

**PHILIPS  
ADVANCE**

LED Driver

CertaDrive

26W 0.55A 46V 0-10V  
(5% dim) 120-277V  
CI026C055V046CNN1



Class P  
LED class 2 output  
For Dry and Damp Location

Intertek  
Class P  
Conforms to UL STD 8750  
Certified to CAN/CSA STD  
C22.2 No. 250.13

Philips Advance CertaDrive indoor LED drivers are designed to meet basic lighting needs. These dimmable drivers are offered with specific voltage-current settings and are, thus, optimized with specifications that are appropriately suited for the application, making LED conversion affordable.

**Specifications**

Input Voltage (Vac)	Output Power (W)	Output Voltage (V)	Output Current (A)	Efficiency@ Max Load and 70°C Case	Max Case Temp. (°C)	Input Current (A)	Max. Input Power (W)	THD @ Max Load (%)	Power Factor @ Max Load	Surge Protection (Ring Wave, KV)	Envir. Protection Rating
120	26	30-46	0.55	86	80°C	0.25	32	<10%	>0.9	2.5	UL damp & dry
277				87		0.11		<15%			

**Enclosure**

	In. (mm)
Case Length	8.34 (212)
Case Width	1.32 (33.5)
Case Height	1.06 (27)
Mounting Length	8.89 (226)
Overall Length	9.45 (240)

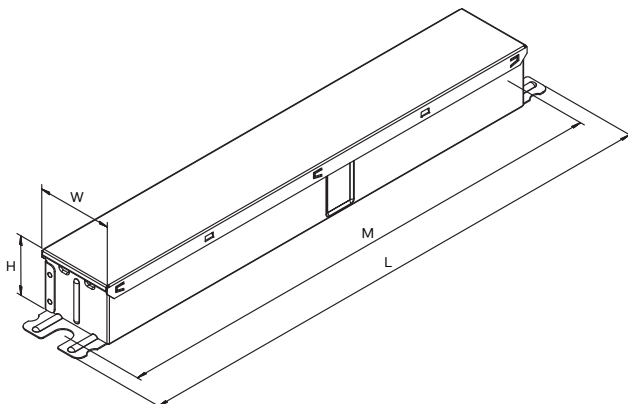

**Wiring Diagram**

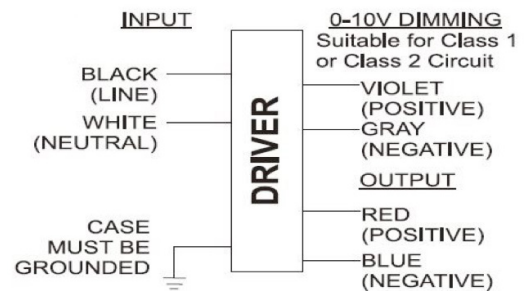

Input and output use lead- wires.

Lead-wires are 18AWG 105C/600V solid copper.

Driver case must be grounded.

Dimming	Dimming Range	Minimum Output Current (A)
0-10V Analog Class 1 and 2 Wiring	5% ~ 100%	0.0275

# CertaDrive 26W 0.55A 46V 0-10V (5% dim) 120-277V

## Features

- 50,000+ hour lifetime<sup>1</sup>
- Excellent thermal performance
- High power factor & low THD<sup>2</sup>

## Benefits

- Enables long life luminaire designs
- Allows operability in indoor (low-bay) ambient conditions
- Suitable for commercial indoor applications

## Application

- Indoor linear troffers, pendants
- Office areas
- Retail centers
- Educational facilities

## Electrical Specifications

All the specifications are typical and at 25°C Tcase unless specified otherwise.

## Product Data

Order Information	
Full Product Code	CI026C055V046CNN1M (Mid-Pack, 30pcs/Box) 12NC:929000763513
Line Frequency	50/60Hz
Min. Mains Voltage Operational	108 Vac
Max. Mains Voltage Operational	305 Vac
Output Information	
Maximum Open Circuit Voltage	60Vdc, Class 2 output
Output Current Ripple (ripple = peak to average / average)	30% max @ max Iout
Output Current Tolerance (at maximum output current)	<8% <sup>2</sup>
Protections	Short Circuit, Open Circuit Protection for LED + and LED -
Features	
0-10V Dimming	See dim curve for detail.
Environment & Approbation	
Operating Ambient Temp. Range	-20°C to +50°C
Max Case Temperature (Tcase) <sup>3</sup>	80°C, Tcase Life: 65°C
Agency Approbations	UL 8750, UL 1310, CSA 250.13, Class P (UL, CSA, ETL)
Electromagnetic Compliance	FCC Title 47 Part 15 Class A
Audible Noise	<24dB Class A
Weight	0.46Lbs / 0.21kgs

1. Philips Advance CertaDrive LED drivers are manufactured to engineering standards correlating to a designed and average life expectancy of 35,000 hours of operation at maximum rated case temperature. Minimum 90% survivals based on MTBF modeling.
2. Note: power factor (PF) and total harmonic distortion (THD) may deviate under adverse mains voltage conditions outside nominal operation. Output current (I out) variation includes effects of line and load regulation, temperature variation and component tolerances.
3. For Tc point location, please refer to the Philips Advance CertaDrive design-in guide.

# CertaDrive 26W 0.55A 46V 0-10V (5% dim) 120-277V

## Electrical Specifications

All the specifications are typical and at 25°C Tcase unless specified otherwise.

### I<sub>out</sub> Vs. V<sub>out</sub>

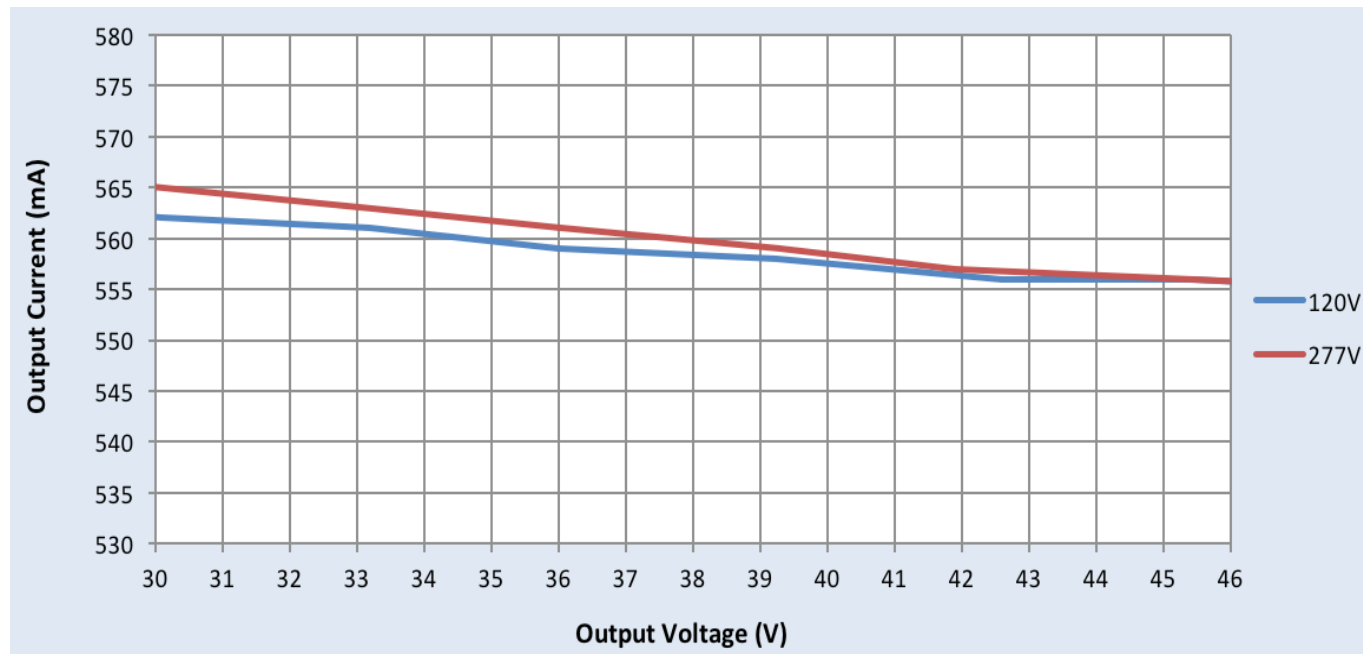

# CertaDrive 26W 0.55A 46V 0-10V (5% dim) 120-277V

## Electrical Specifications

All the specifications are typical and at 25°C Tcase unless specified otherwise.

### 0-10V Dimming Curve

Dimming source current from the driver: 150µA (@ 0<Vdim<8V)

Minimum dim level: 5% of Iout

Maximum output voltage on the dimming wires: 12V

### Approved Dimmer List

Manufacturer	Manufacturer Part Number
Lutron	Visit <a href="http://www.lutron.com/advance">www.lutron.com/advance</a> for a list of dimmers (Mark VII) that will work with this driver
Leviton	IllumaTech IP7 series
Philips	Sunrise - SR1200ZTUNV

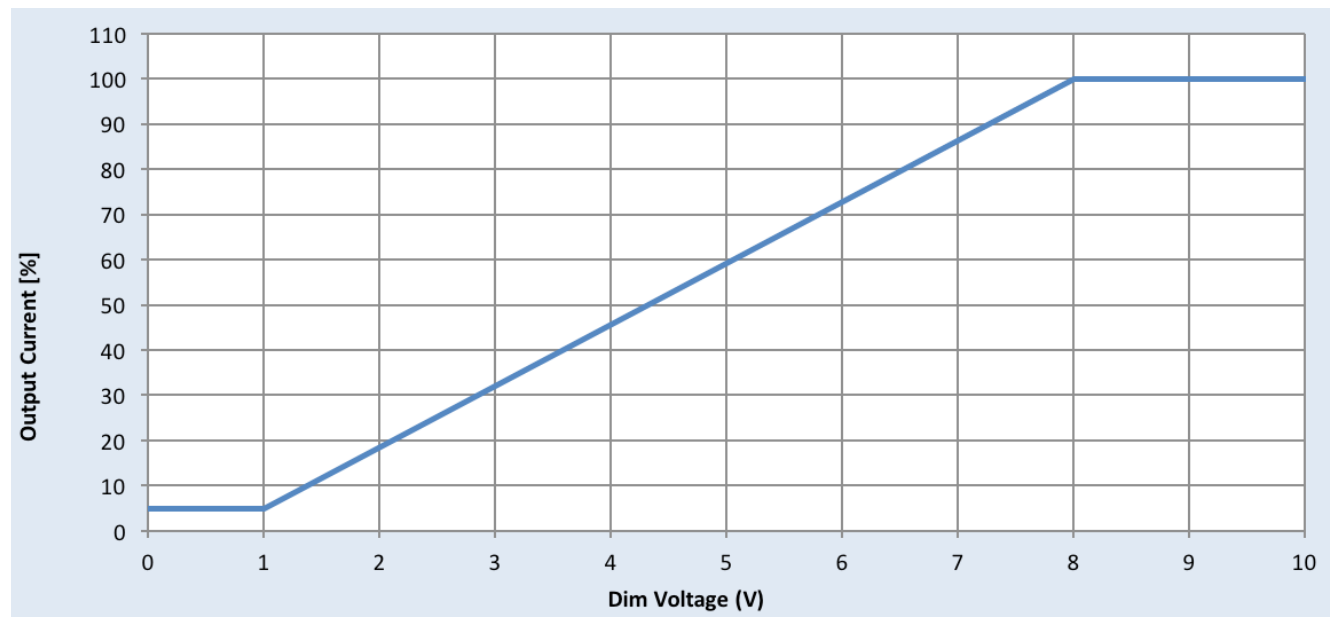

# CertaDrive 26W 0.55A 46V 0-10V (5% dim) 120-277V

## Electrical Specifications

All the specifications are typical and at 25°C Tcase unless specified otherwise.

### Output Current Vs. Driver Case Temperature

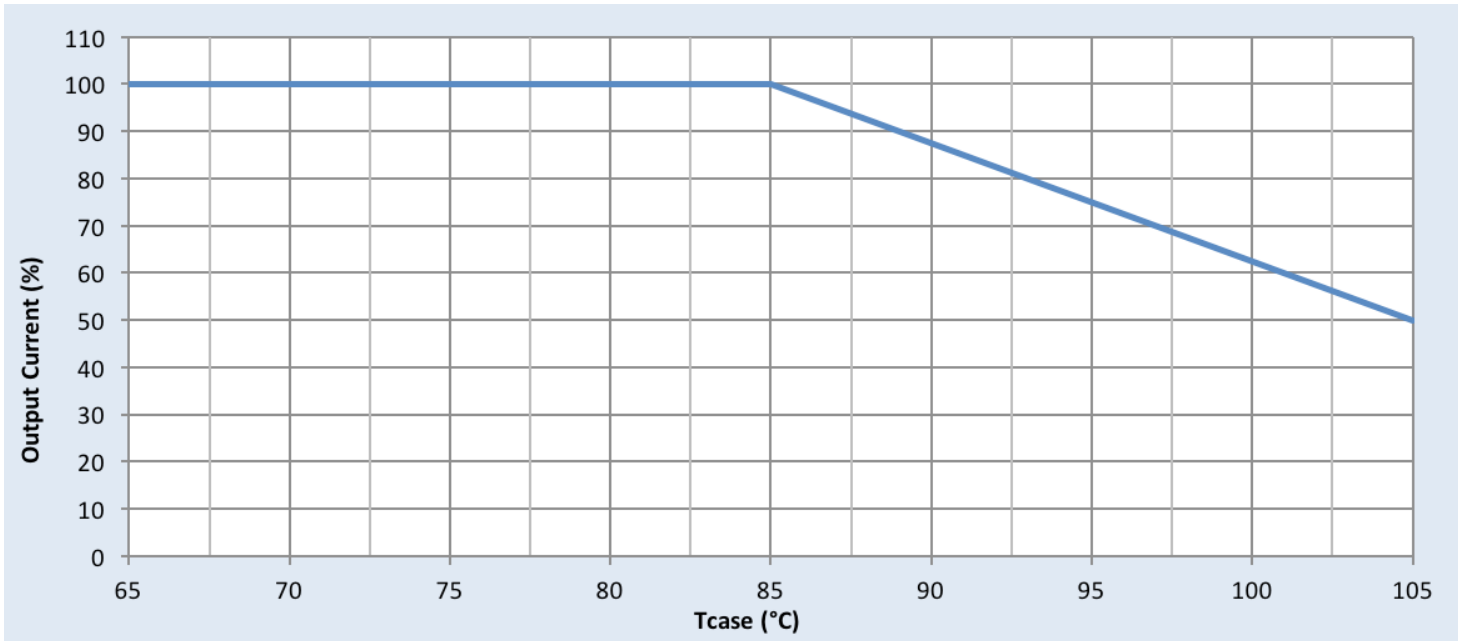

Note: There is  $\pm 5^\circ\text{C}$  tolerance on the driver case temperature.

### Driver Lifetime Vs. Driver Case Temperature

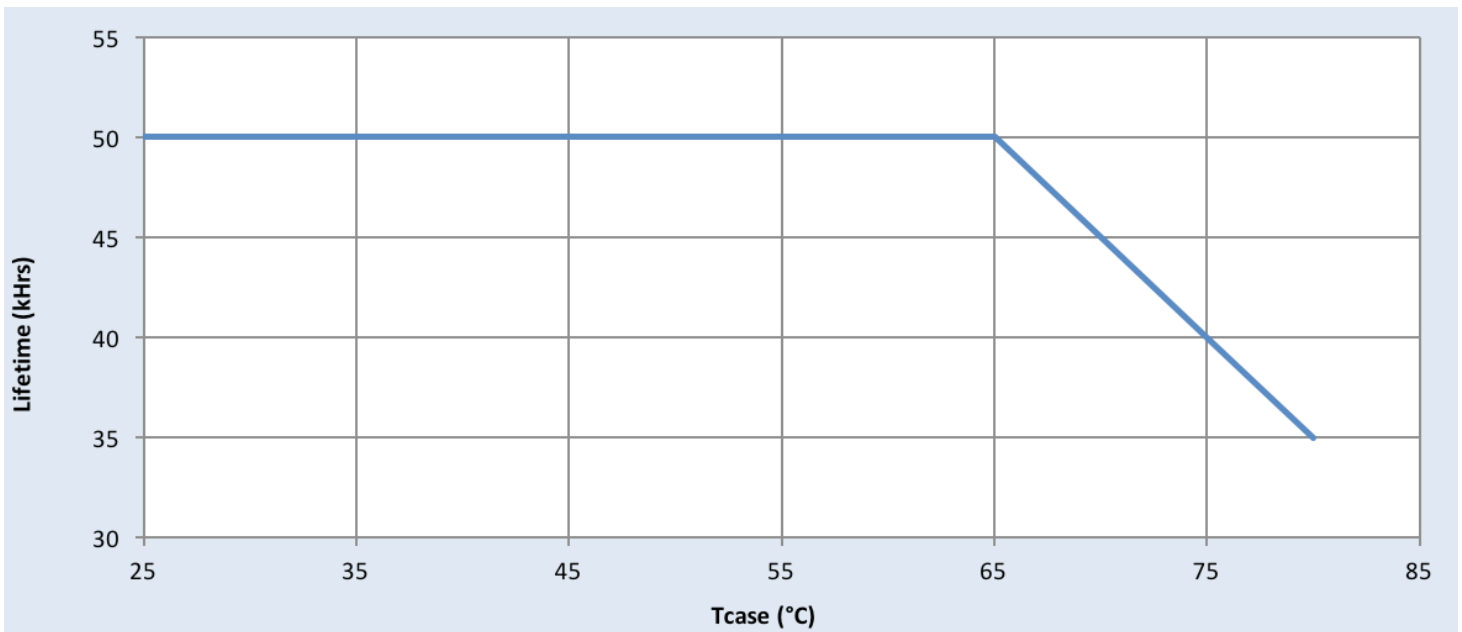

# CertaDrive 26W 0.55A 46V 0-10V (5% dim) 120-277V

## Performance Characteristics

Based on measurements on a typical sample at 70°C case. The accuracy of the measurements is within the tolerance of the measurement instruments.

## Efficiency Vs. Output Voltage

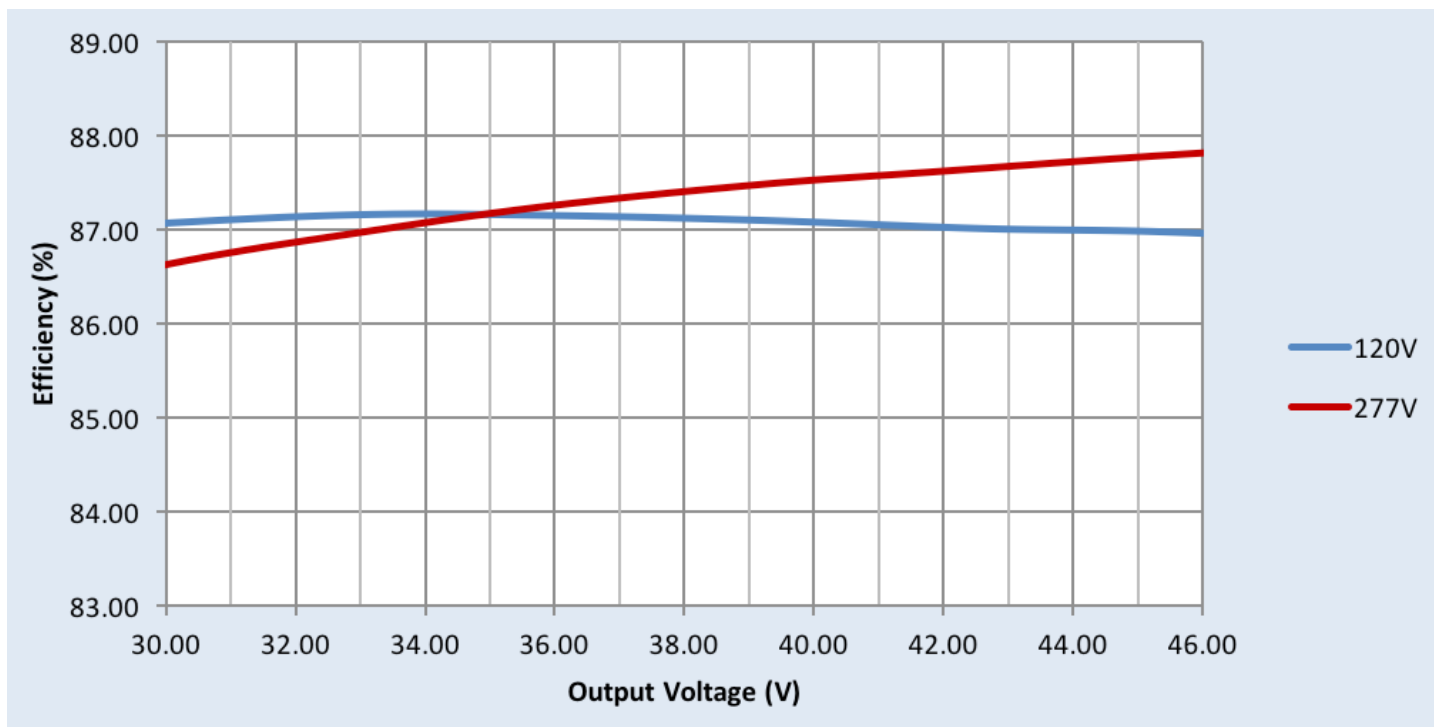

# CertaDrive 26W 0.55A 46V 0-10V (5% dim) 120-277V

## Performance Characteristics

Based on measurements on a typical sample at 70°C case. The accuracy of the measurements is within the tolerance of the measurement instruments.

### Power Factor Vs. Output Power

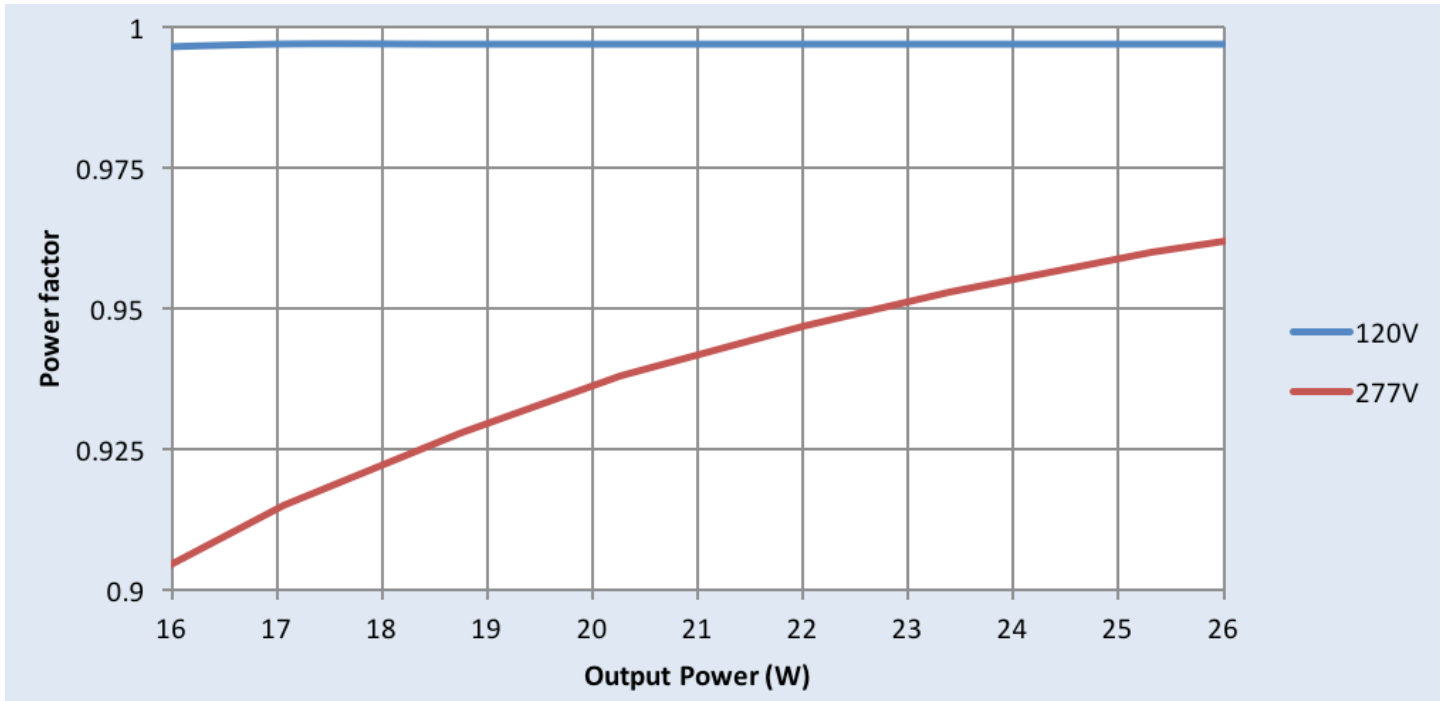

### Total Harmonic Distortion (THD) Vs. Output Power

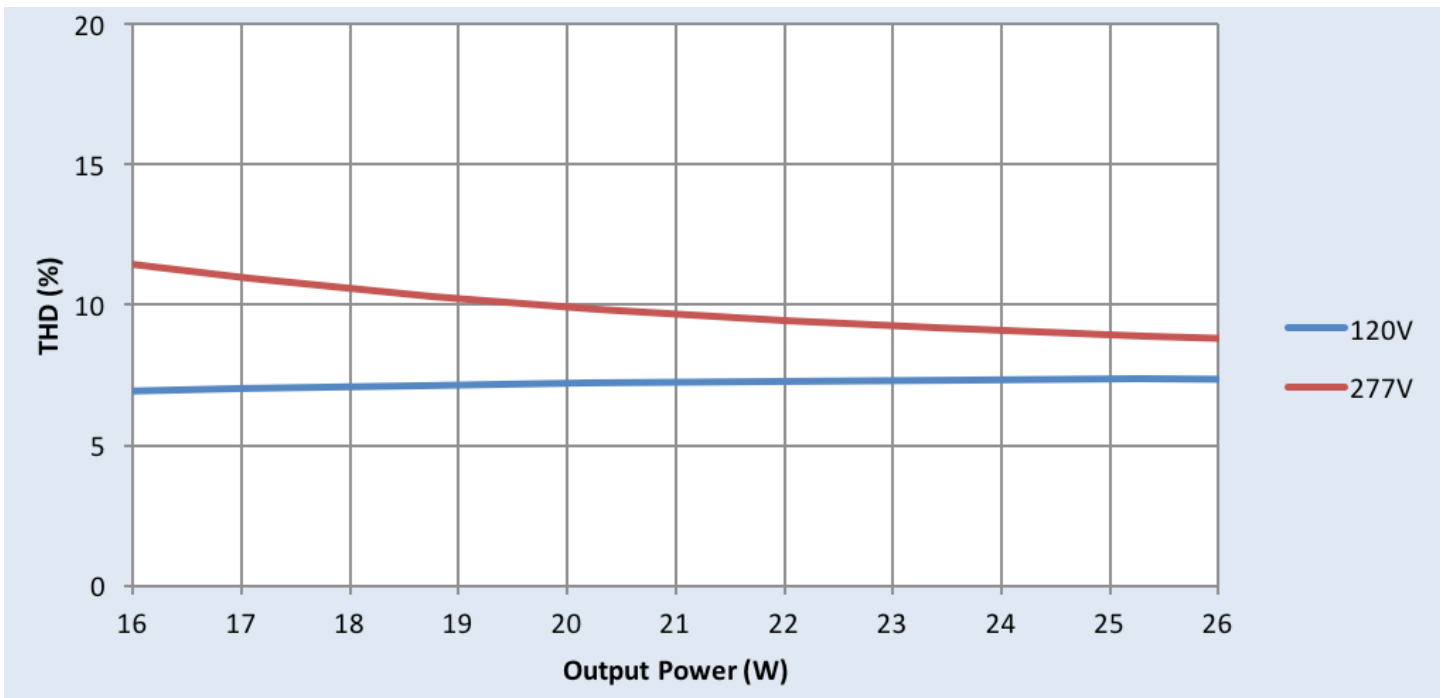

# CertaDrive 26W 0.55A 46V 0-10V (5% dim) 120-277V

## Inrush Current Info

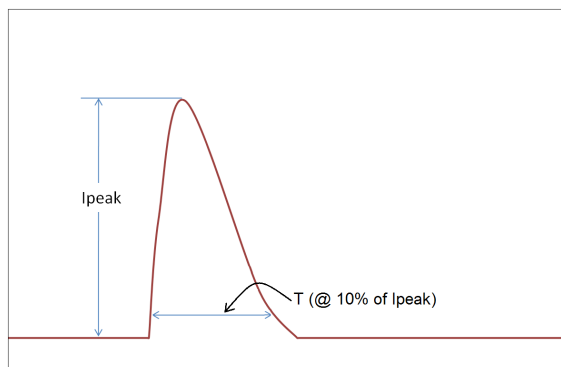

Vin	Ipeak	T (@ 10% of Ipeak)
120 Vrms	8A	6μS
277 Vrms	21A	8μS

Inrush current is measured at peak of the corresponding line voltage. Source impedance per NEMA 410.

## Lightning Surge Info

ANSI Surge Type	Differential Mode (L-N)	Common Mode (L-G, N-G, L&N-G)
100 kHz Ring Wave (w/t 30Ω)	2.5kV	2.5kV

## Isolation

Isolation	Input	Output	0-10V	Enclosure
Input	NA	2xU+1kV	2.5kV	2xU+1kV
Output	2xU+1kV	NA	2.5kV	2xU+1kV
0-10V	2.5kV	2.5kV	NA	2xU+1kV
Enclosure	2xU+1kV	2xU+1kV	2xU+1kV	NA

U = Max working voltage

© 2016 Philips Lighting Holding B.V. All rights reserved.  
Philips reserves the right to make changes in specifications and/or to discontinue any product at any time without notice or obligation and will not be liable for any consequences resulting from the use of this publication.  
[philips.com/leddrivers](http://philips.com/leddrivers)



Philips Lighting North America Corporation  
10275 W. Higgins Road, Rosemont IL 60018  
Tel: 800-322-2086 Fax: 888-423-1882  
Customer/Technical Service: 800-372-3331  
OEM Support: 866-915-5886

Philips Lighting Canada Ltd.  
281 Hillmount Rd, Markham, ON, Canada L6C 2S3  
Tel. 800-668-9008